

# Vector Frame Kit 09

## VF-K-09A



The innovative, contemporary and clean appearance of the Vector Frame™ line of exhibit kits will captivate your audience. Kits feature push-fit fabric graphics, easy-to-assemble extrusion frames, accent lighting, tables, literature accessories, monitor mounts and interior LED edge lighting where indicated.



## features and benefits:

- 50mm silver extrusion frame
- Single-sided fabric graphics
- Kit includes: one frame, one dye-sublimated graphic, four accent wings, two 120 watt lights, one counter and one wheeled molded case
- Lifetime hardware warranty against manufacturer defects

## dimensions:

Hardware	Graphic
<p>Assembled Unit: 117" w x 102" h x 23" d 2972mm(w) x 2591mm(h) x 584mm(d)</p> <p>Approximate weight: 52 lbs / 24 kg</p>	<p>Refer to related graphic template for more information.</p> <p>Visit: <a href="https://www.theexhibitorshandbook.com/download-graphic-templates">https://www.theexhibitorshandbook.com/download-graphic-templates</a></p>
Shipping	additional information:
<p>Packing case(s): 1 OCE</p> <p>Shipping dimensions: OCE: Expandable case length (l) may vary 40" - 66" l x 18" h x 18" d 1016mm-1677mm(l) x 458mm(h) x 458mm(d)</p> <p>Approximate total shipping weight: 79 lbs / 36 kg</p>	<p>Graphic material: Dye-sublimation SEG push-fit fabric</p> <p>Counter: 38.5" w x 40.5" h x 19.88" d 978mm(w) x 1029mm(h) x 505mm(d)</p> <p>Counter holds max weight: 100 lbs / 46 kg</p> <p>Lights Included: Lumina 200</p> <p> This product may include the following materials for recycle: aluminum, select wood, fabric, cardboard, paper, steel, and plastics.</p> <p><b>2 person assembly recommended:</b></p> <p></p>

We are continually improving and modifying our product range and reserve the right to vary the specifications without prior notice. All dimensions and weights quoted are approximate and we accept no responsibility for variance. E&OE. See Graphic Templates for graphic bleed specifications.

\*Not to scale

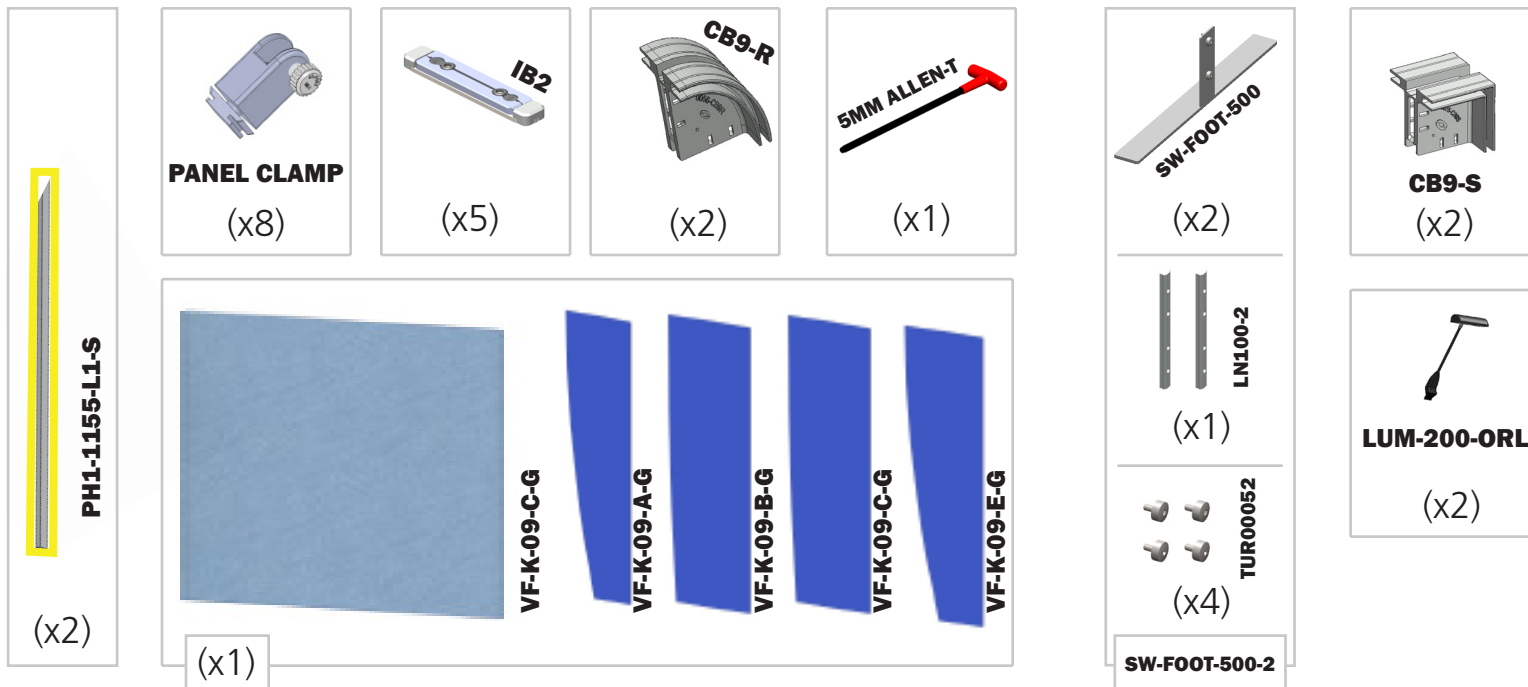
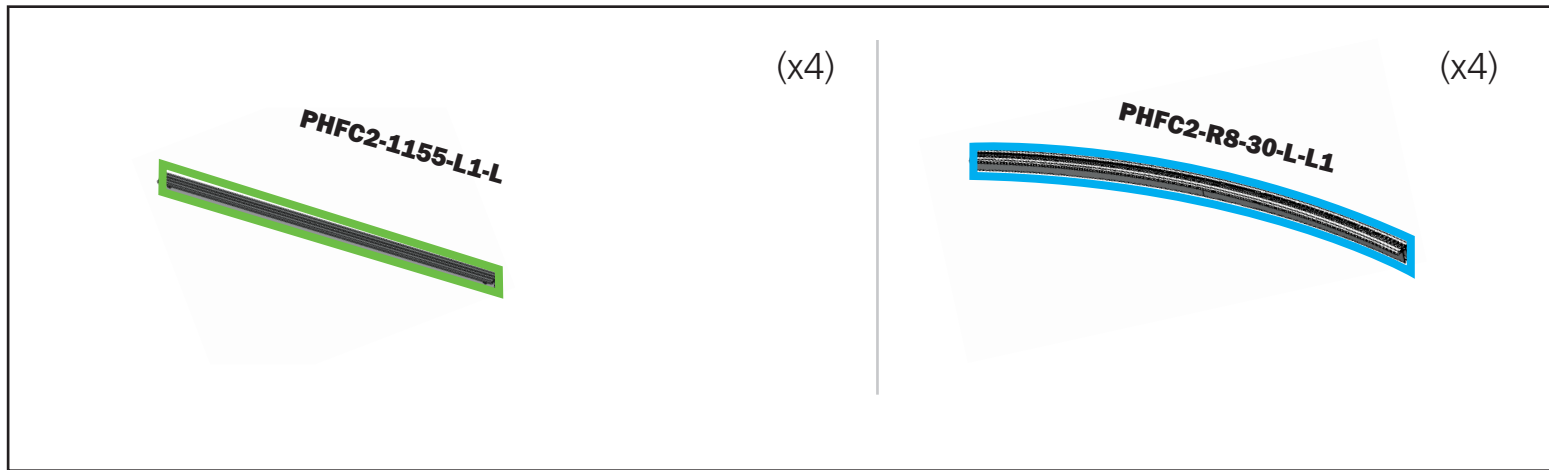

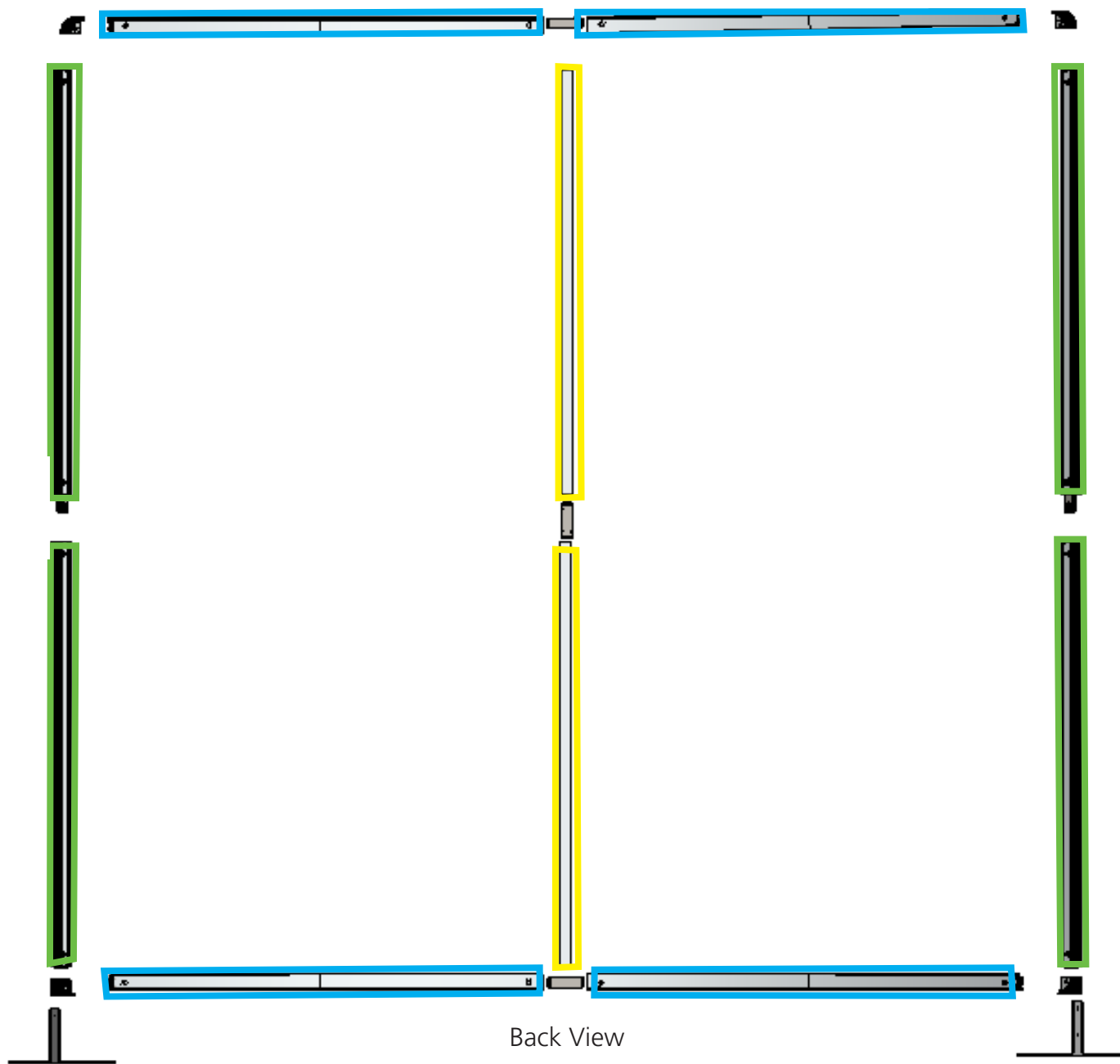

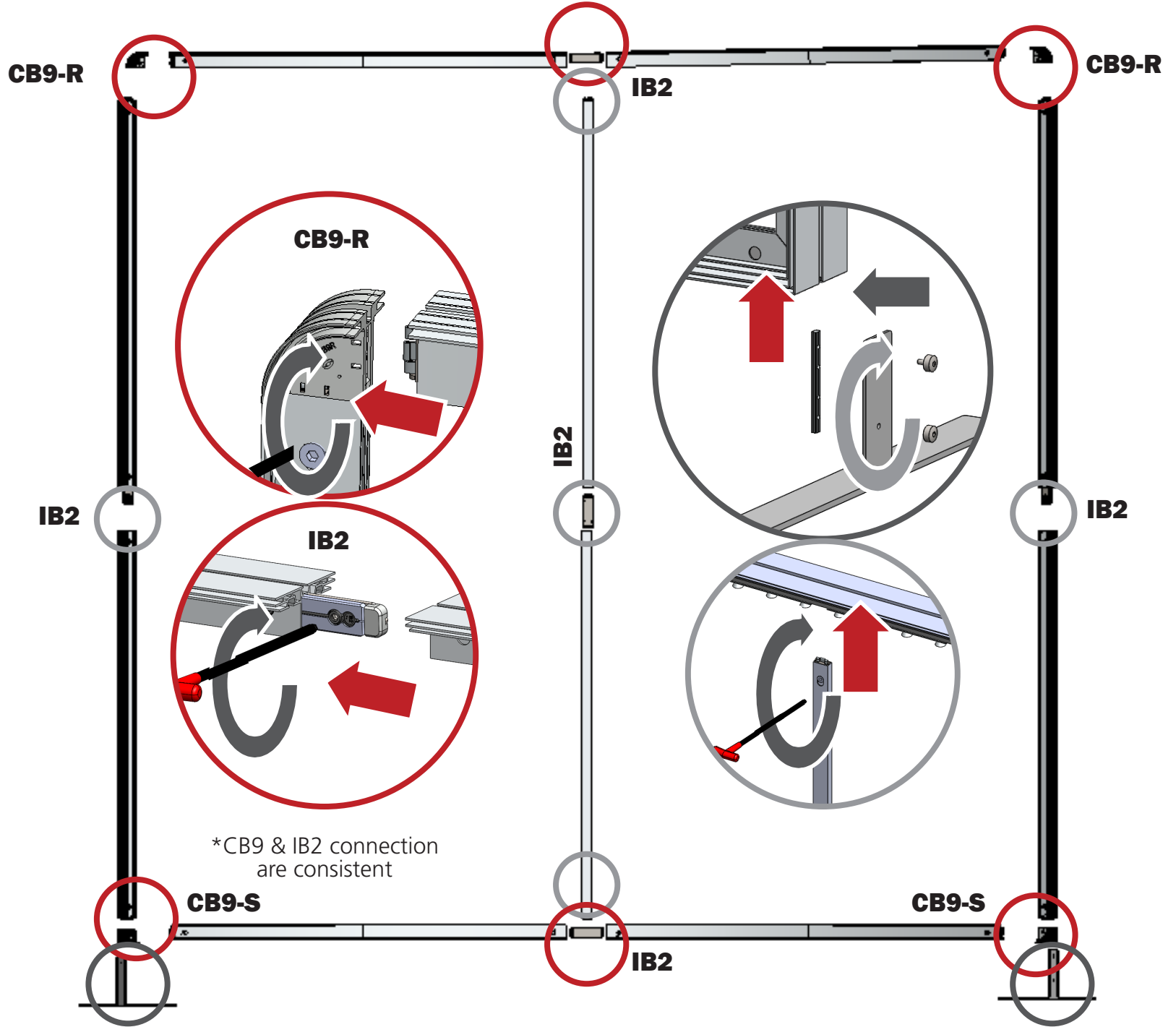

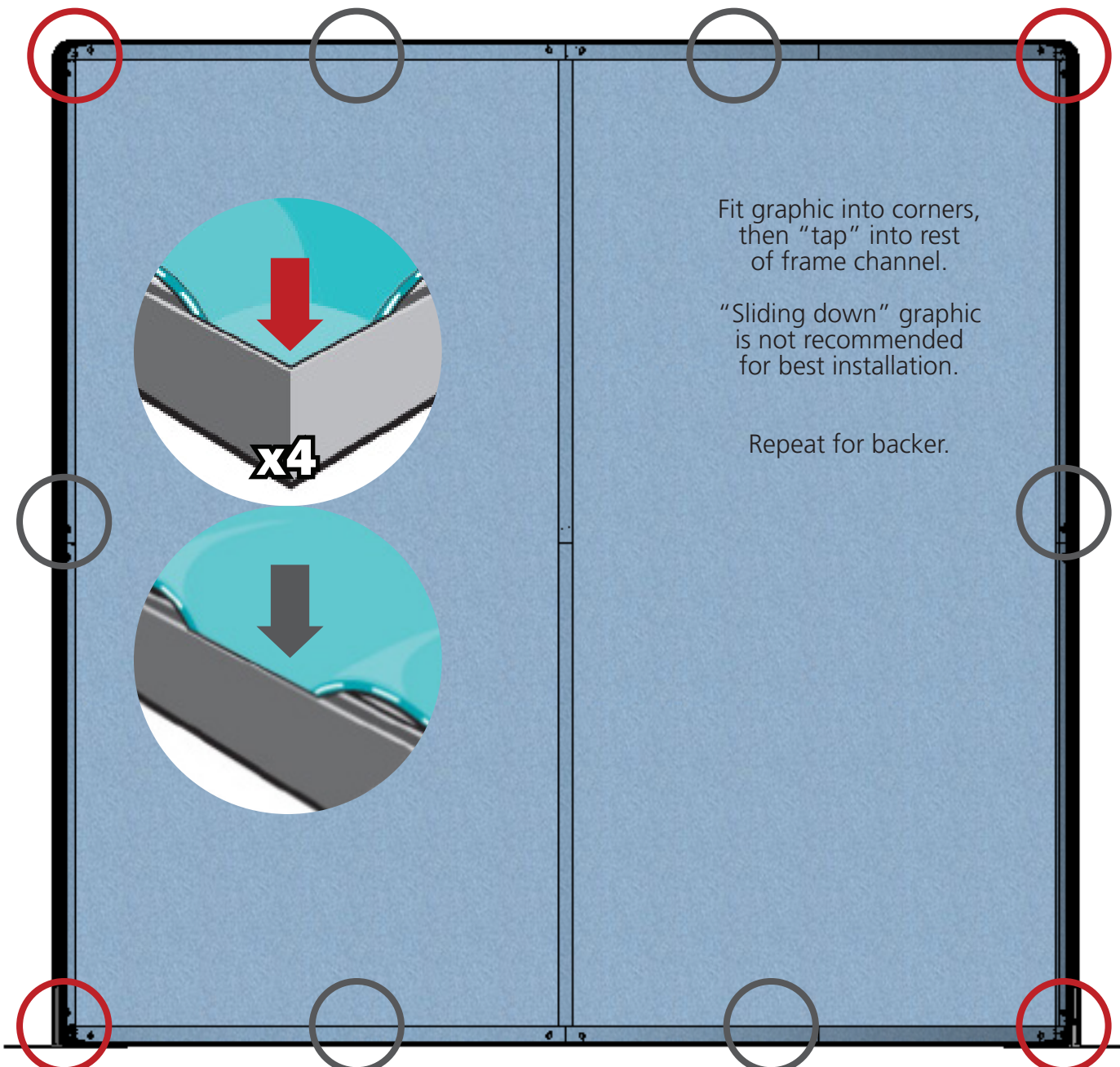

Fit graphic into corners,  
then "tap" into rest  
of frame channel.

"Sliding down" graphic  
is not recommended  
for best installation.

Repeat for backer.

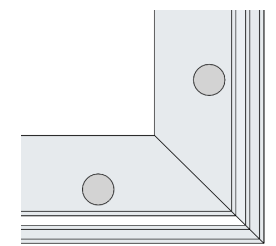
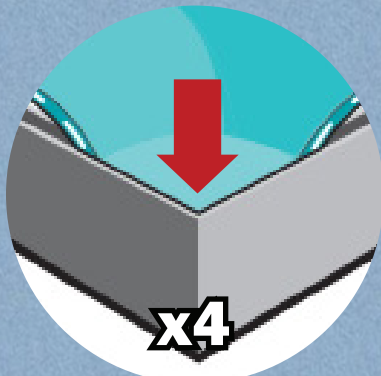

Backer  
2nd channel

Graphic  
1st channel



