

Perfect 10 Hybrid Displays

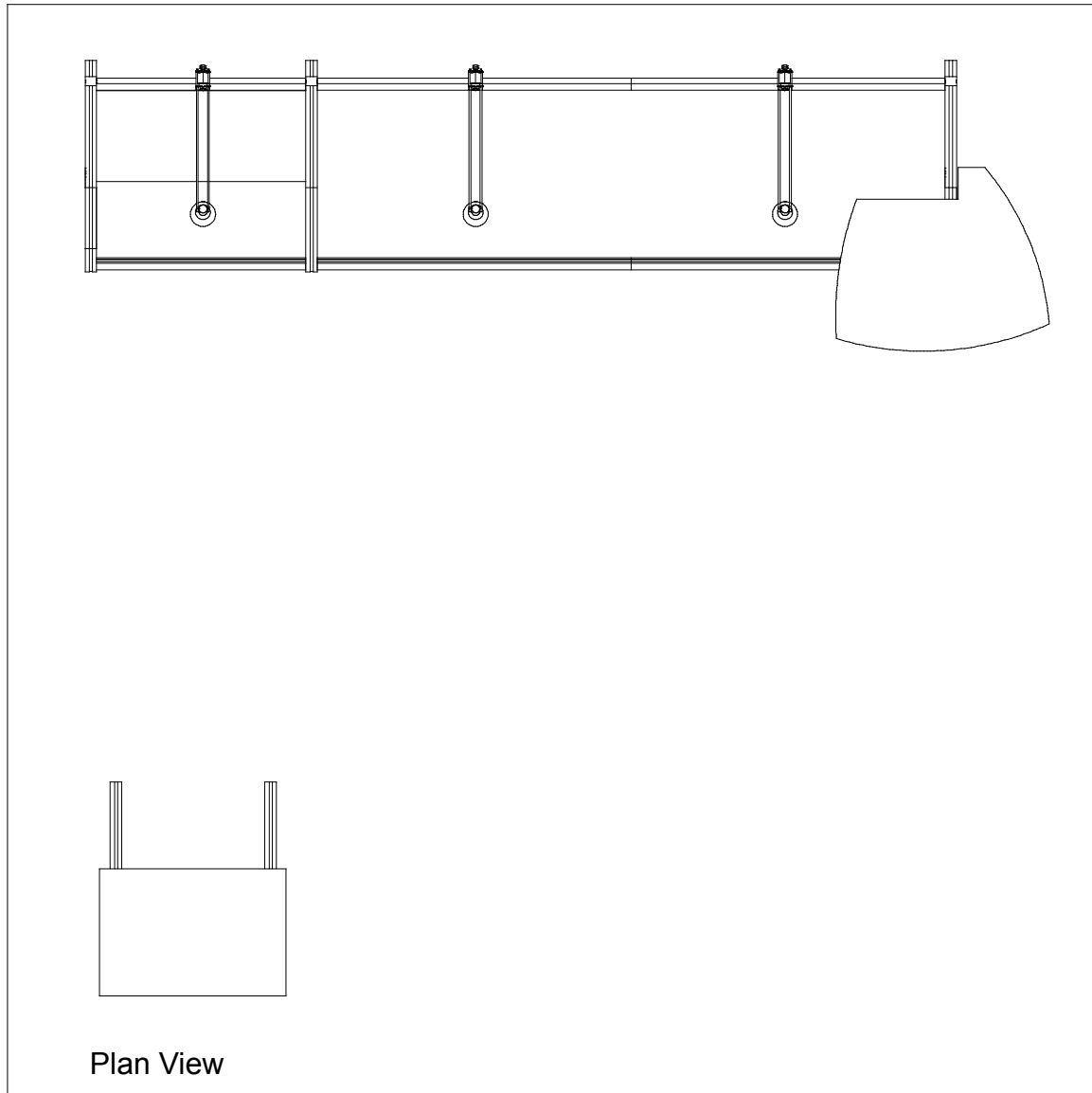

10'

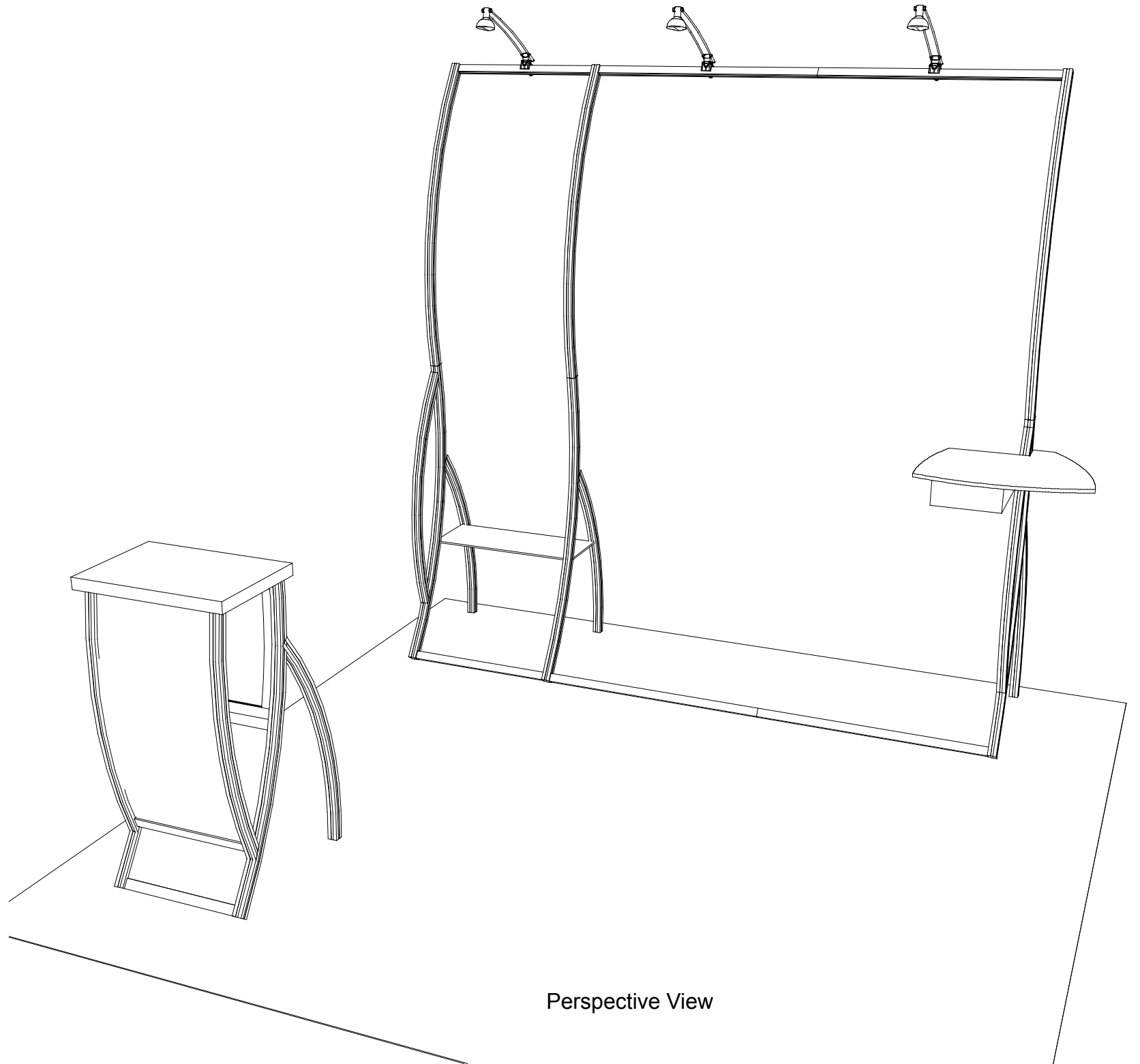

WHEN DISASSEMBLING TIGHTEN ALL KNOBS TO PREVENT LOSS DURING SHIPPING

866.652.2100

Item	Qty.	Description
1	1	Left Leg Assembly
2	1	Middle Leg Assembly
3	1	Upper Curved Vertical
3a	1	Upper Curved Vertical
4	2	23" w Horizontal
5	1	Right Leg Assembly
6	1	Upper Curved Vertical
7	1	69" w Horizontal
8	1	69" w Horizontal

Steps:
 NOTE: Assembly may be easiest if assembled face down on floor then lifted upright.
 1) Connect upper curved vertical extrusions [3a,3,6] to leg assemblies [1,2,5].
 2) Connect lower and upper horizontal extrusions between vertical assemblies by slightly tightening BLACK knobs on backside of extrusion as shown.
 NOTE: Make sure velcro faces toward back and knobs face horizontally as shown in detail.

**** Various Accessories Available ****

NOTE: When assembling horizontals they should be placed approximately one inch from TOP and BOTTOM.

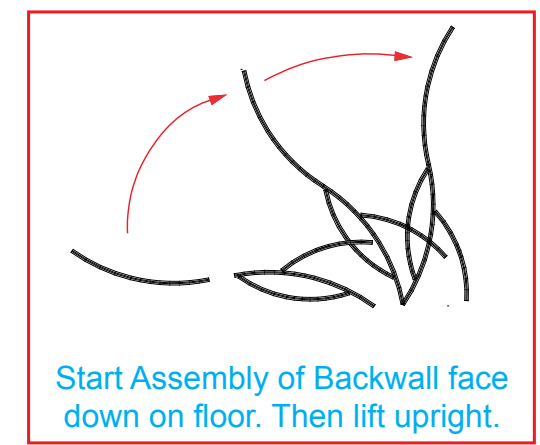
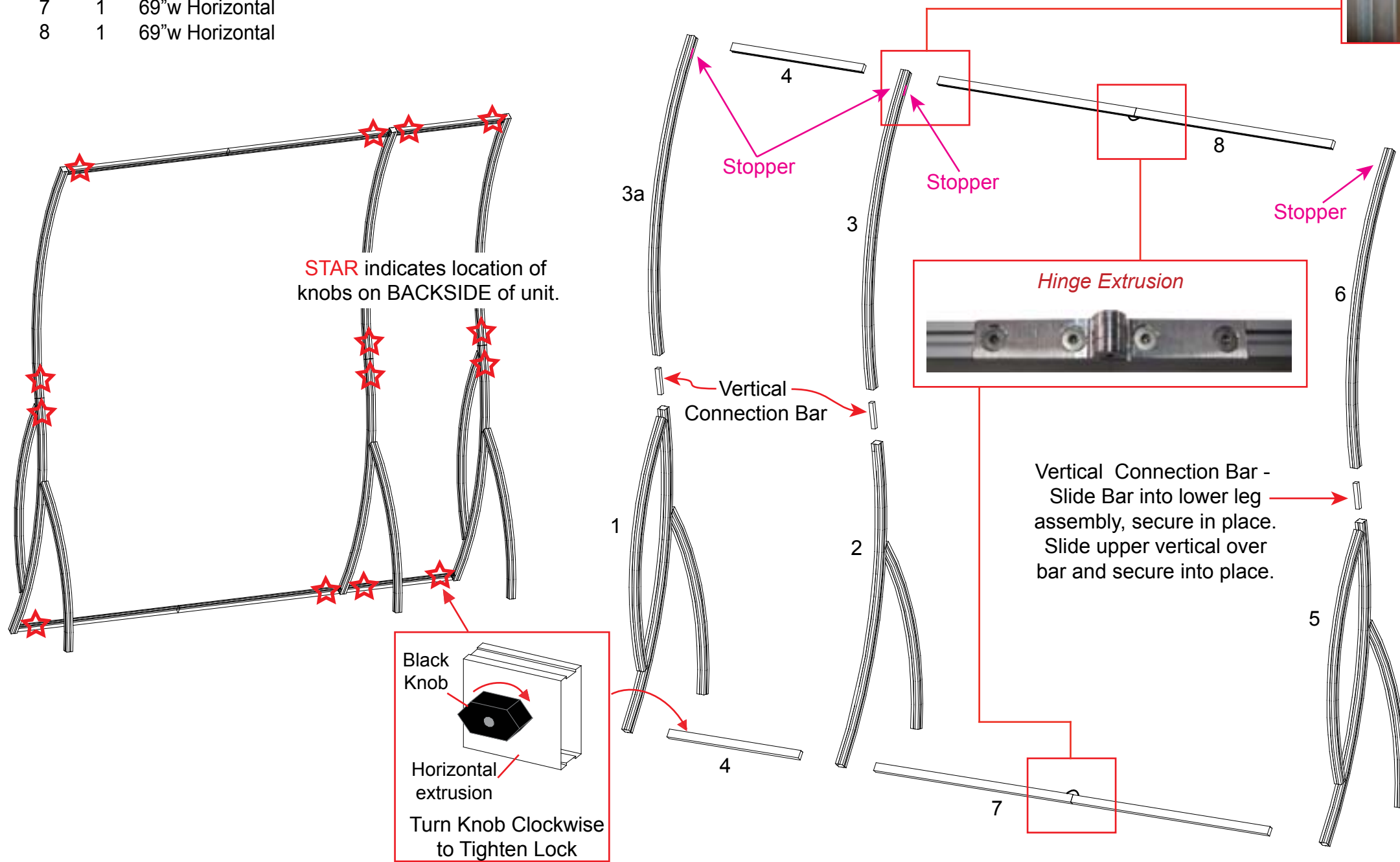

Step stool may be required for assembly.



WHEN DISASSEMBLING TIGHTEN ALL KNOBS TO PREVENT LOSS DURING SHIPPING

866.652.2100

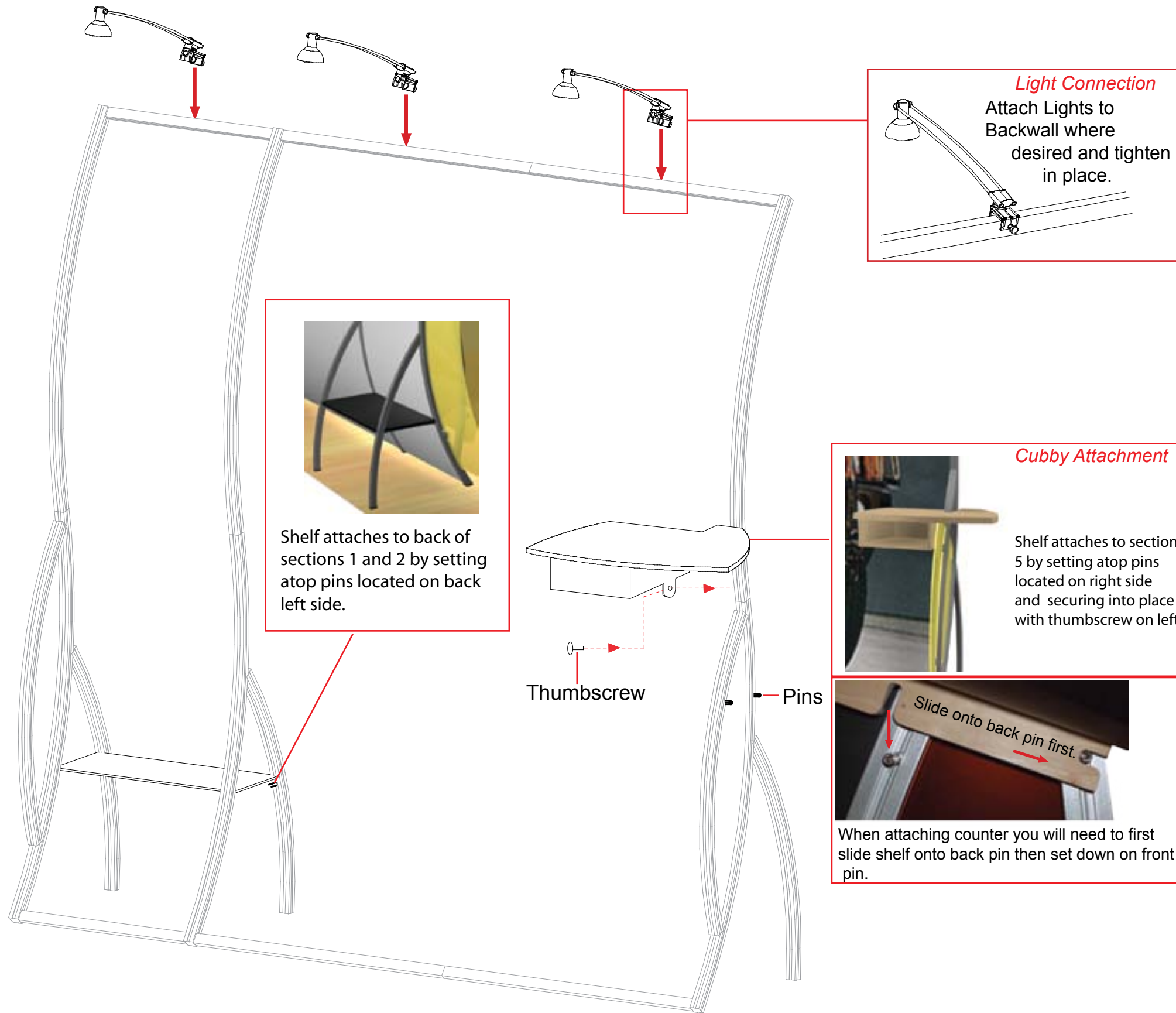

Light Connection
 Attach Lights to Backwall where desired and tighten in place.

Shelf attaches to back of sections 1 and 2 by setting atop pins located on back left side.

Cubby Attachment
 Shelf attaches to section 5 by setting atop pins located on right side and securing into place with thumbscrew on left.

Slide onto back pin first.
 When attaching counter you will need to first slide shelf onto back pin then set down on front pin.

Thumbscrew
 Pins

WHEN DISASSEMBLING TIGHTEN ALL KNOBS TO PREVENT LOSS DURING SHIPPING

Part Number	Description
A	Left Leg Assembly
B	Right Leg Assembly
C	Horizontal Extrusion
D	Horizontal Extrusion w/ Door Stopper

Steps:

- 1) Connect lower horizontal extrusion [C] between bottom of leg assemblies [A and B] as shown.
- 2) Insert Laminated infill into grooves of leg assemblies [A and B].
- 3) Attach extrusion door between leg assemblies [A and B] and on top of laminated infill.
- 4) Attach upper horizontal extrusion w/ door stopper [D] between leg assemblies [A and B], and set flush with top of legs [A and B].

NOTE: Make sure the lock is flush with extrusion before tightening. If lock will not fully engage, gently rock lock and extrusion back and forth while turning knob until lock fully opens.

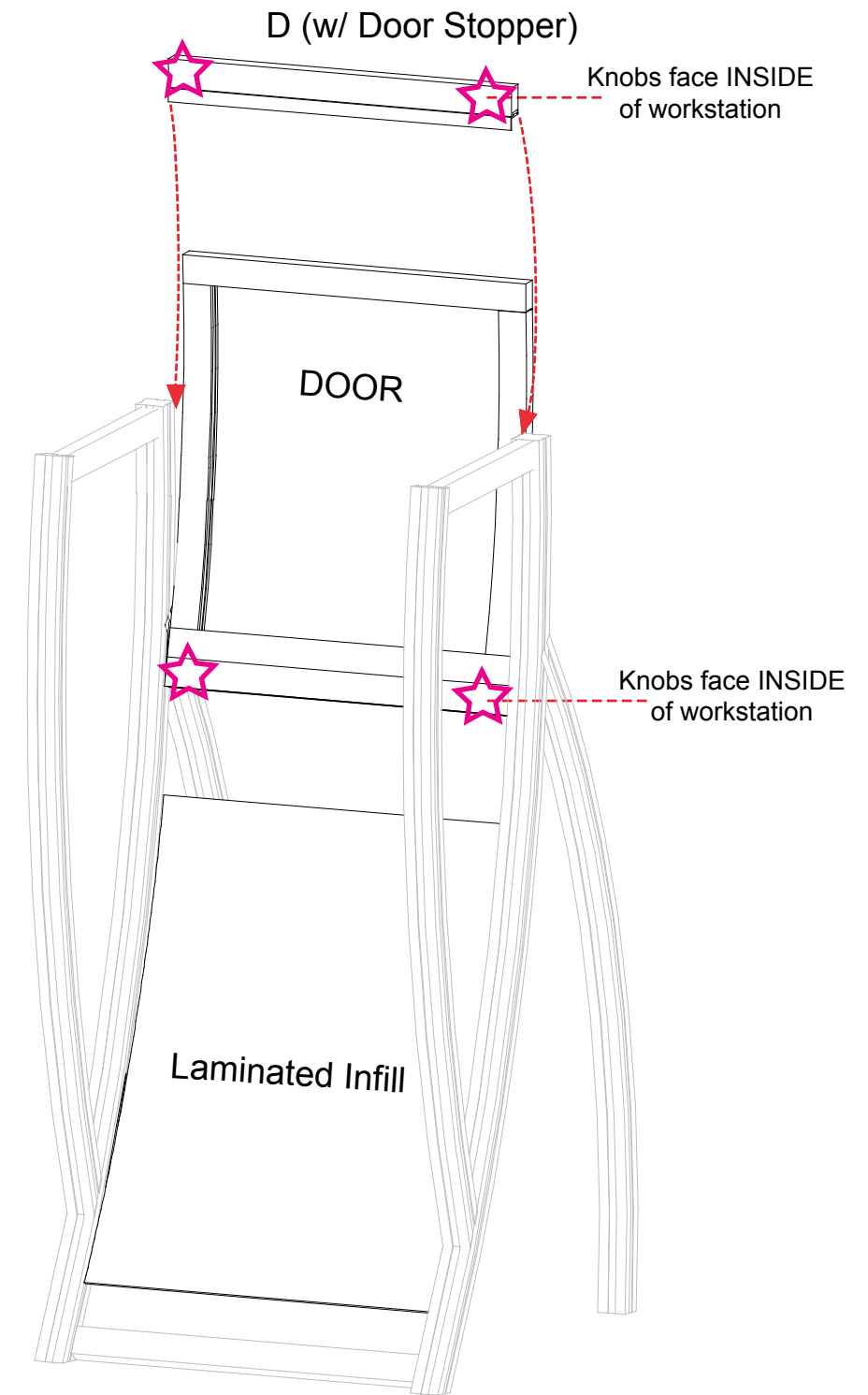
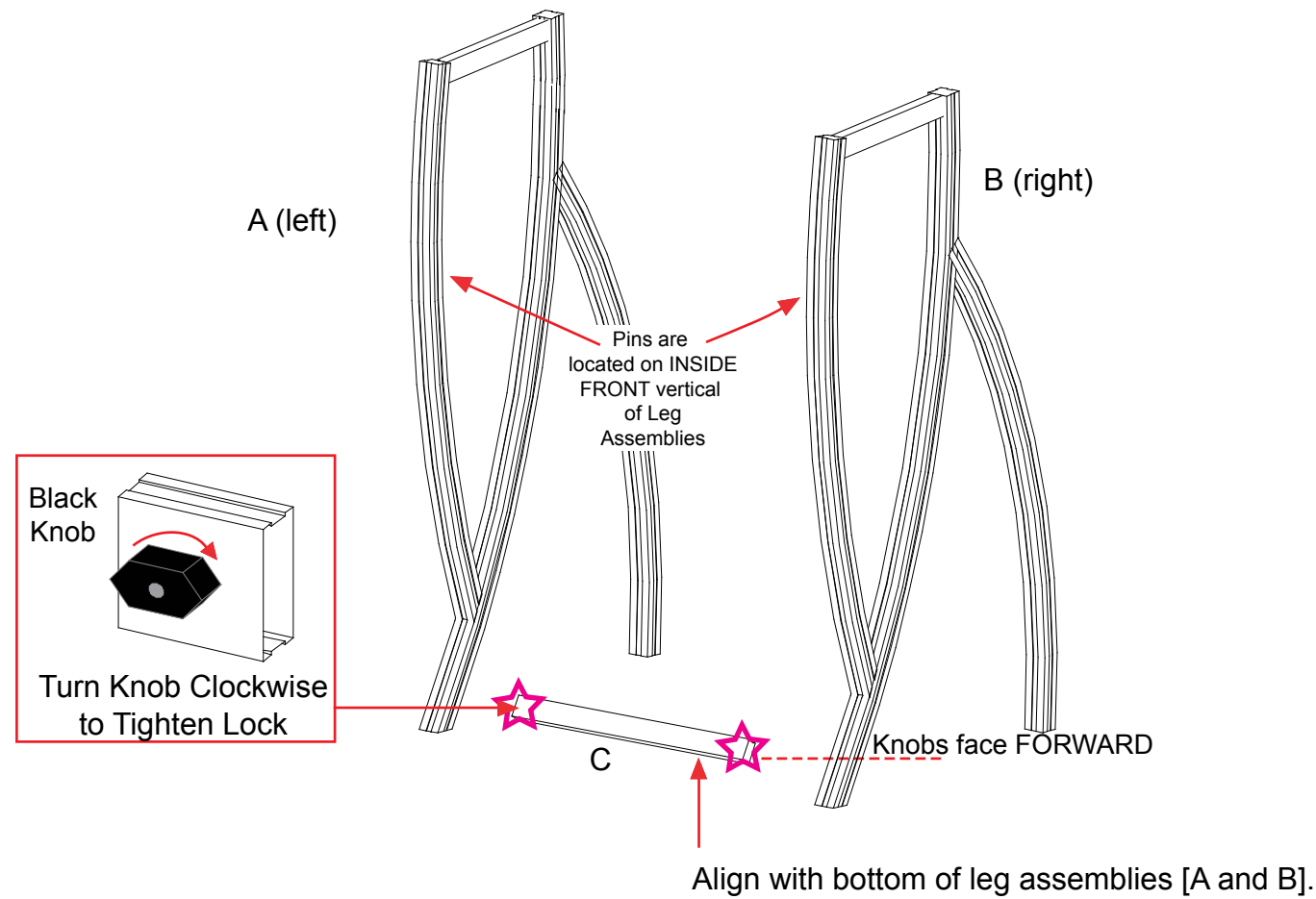

WHEN DISASSEMBLING TIGHTEN ALL KNOBS TO PREVENT LOSS DURING SHIPPING

866.652.2100

Part Number	Description
E	Horizontal Extrusion
F	Horizontal Extrusion

Steps:

- 1) Attach horizontal extrusion [E] between vertical leg assemblies [A and B] as shown below.
- 2) Insert Laminated infill into grooves of vertical leg assemblies [A and B].
- 3) Attach upper horizontal extrusion [F] between vertical leg assemblies [A and B] atop infill.
- 4) Place internal shelf into assembled pedestal atop pins..
- 5) Set Counter atop assembled pedestal and secure with Velcro straps attached to underside of top.

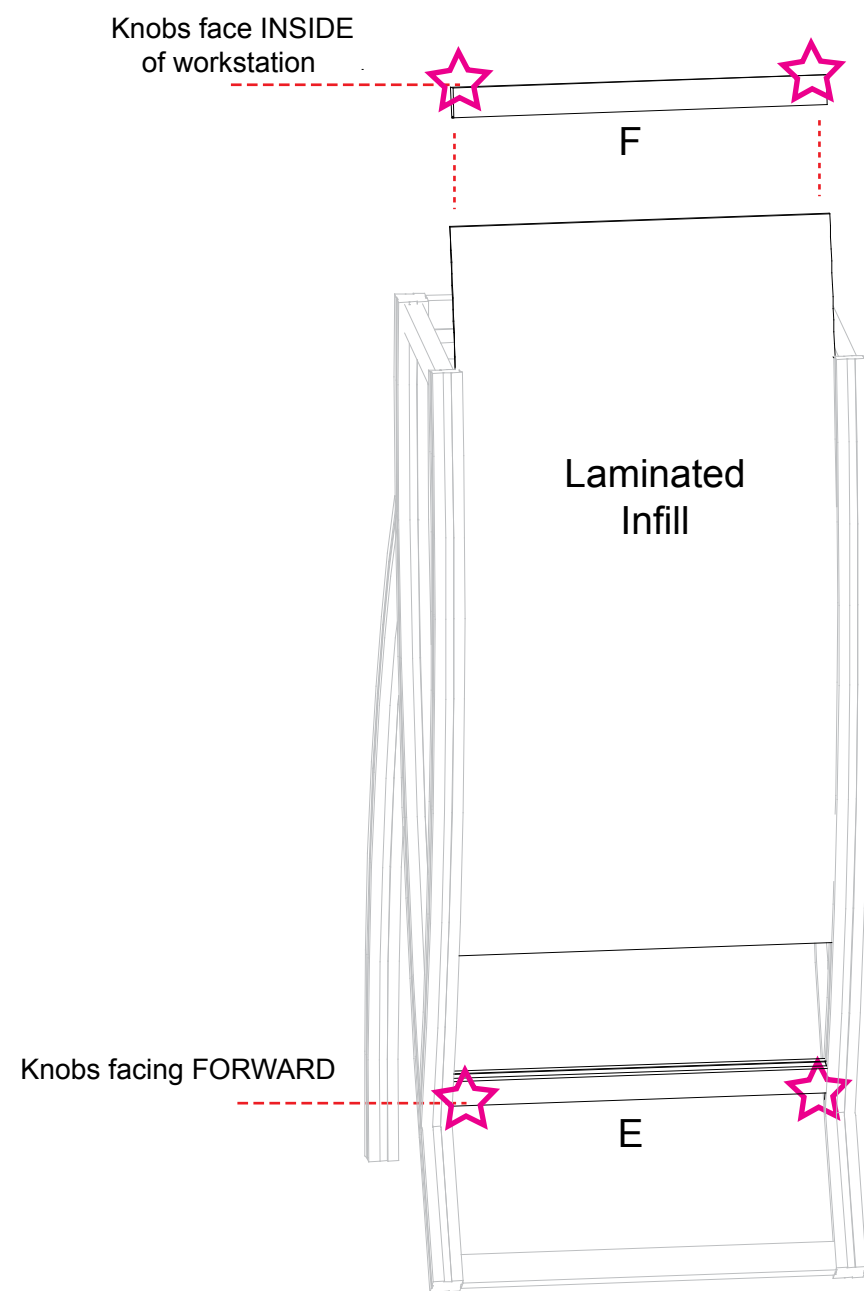

Place internal shelf into workstation then place counter atop assembled workstation.

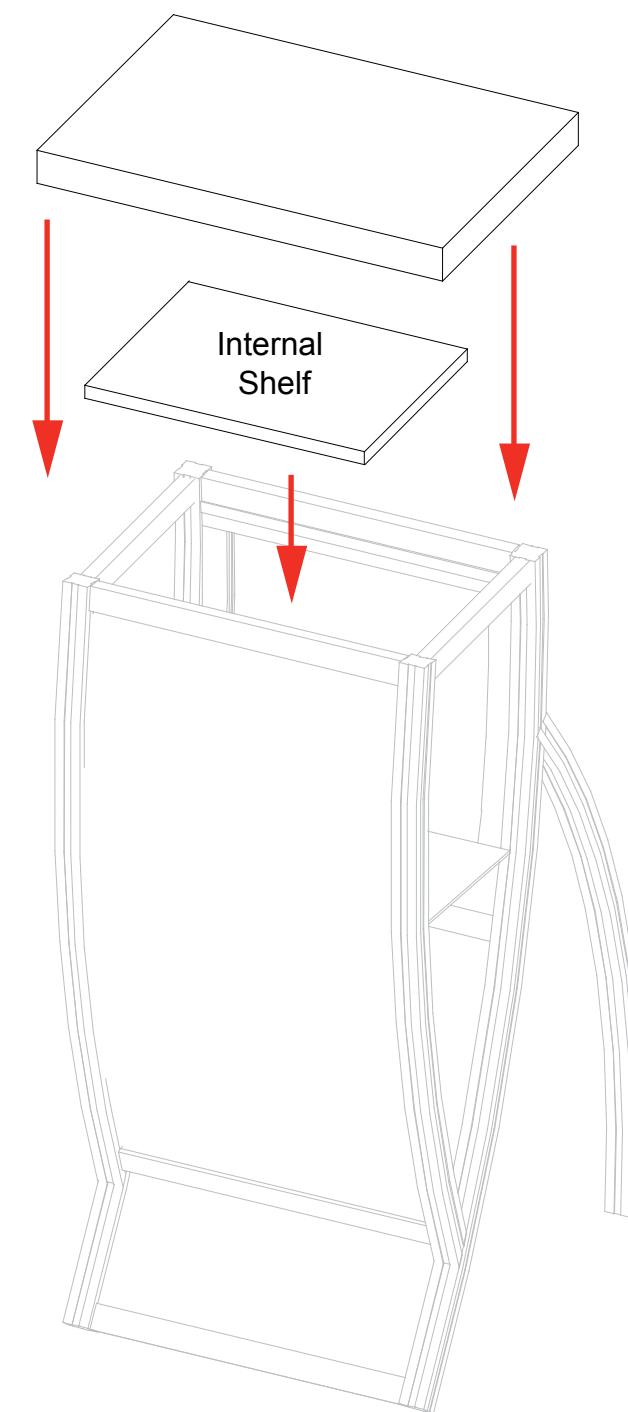

WHEN DISASSEMBLING TIGHTEN ALL KNOBS TO PREVENT LOSS DURING SHIPPING

Top View

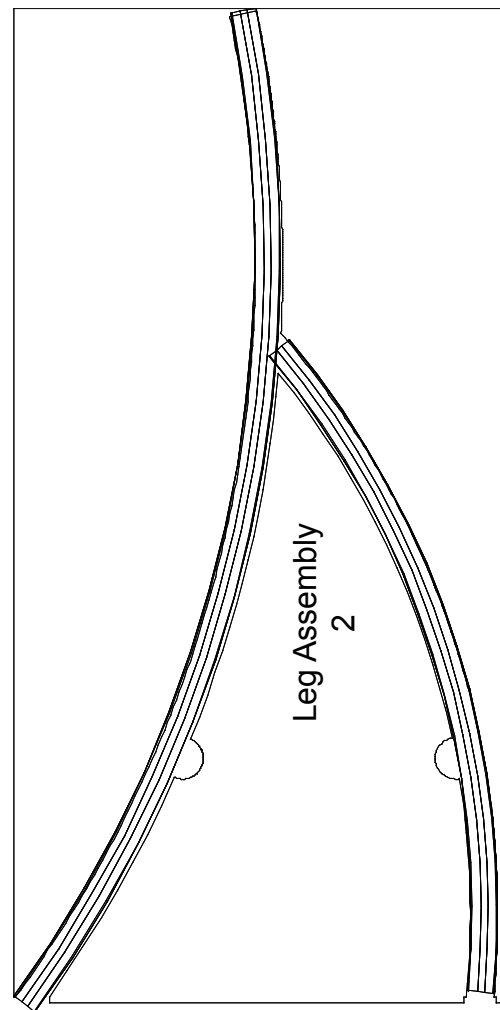

Level 1

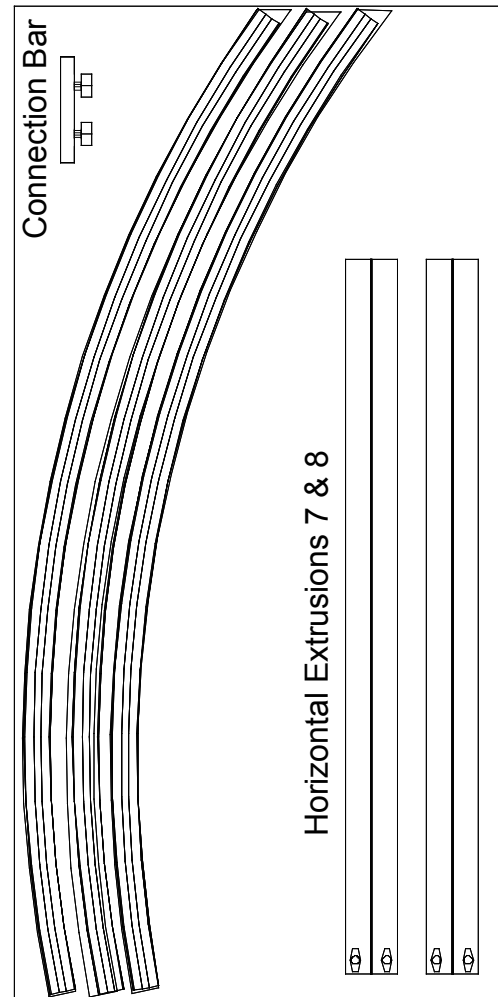

Level 2

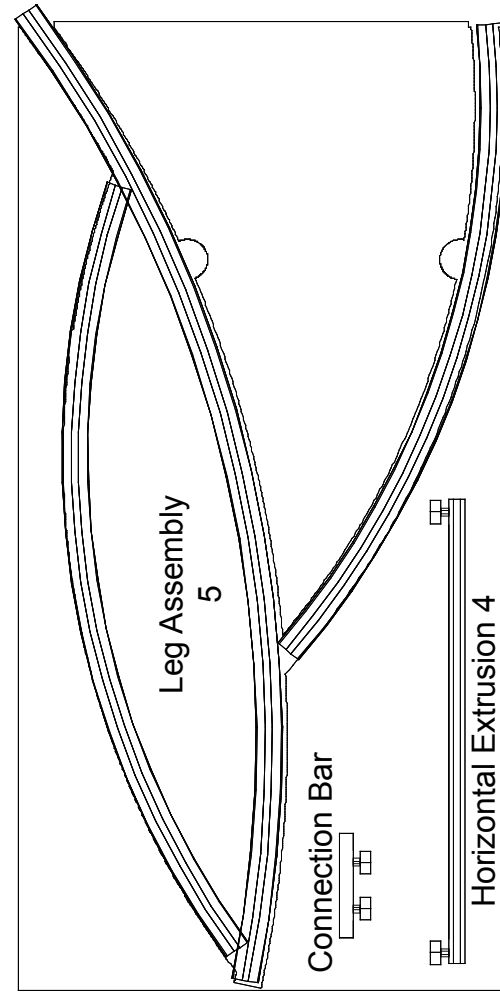

Level 3

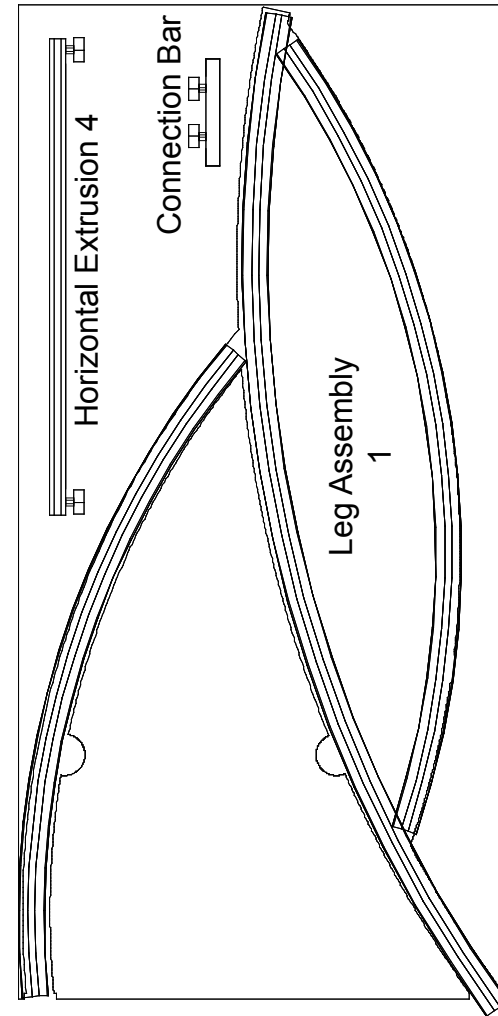

Level 4

- Additional Items:**
- Setup Hardware
 - Graphic
 - (3) Lights

WHEN DISASSEMBLING TIGHTEN ALL KNOBS TO PREVENT LOSS DURING SHIPPING

Top View

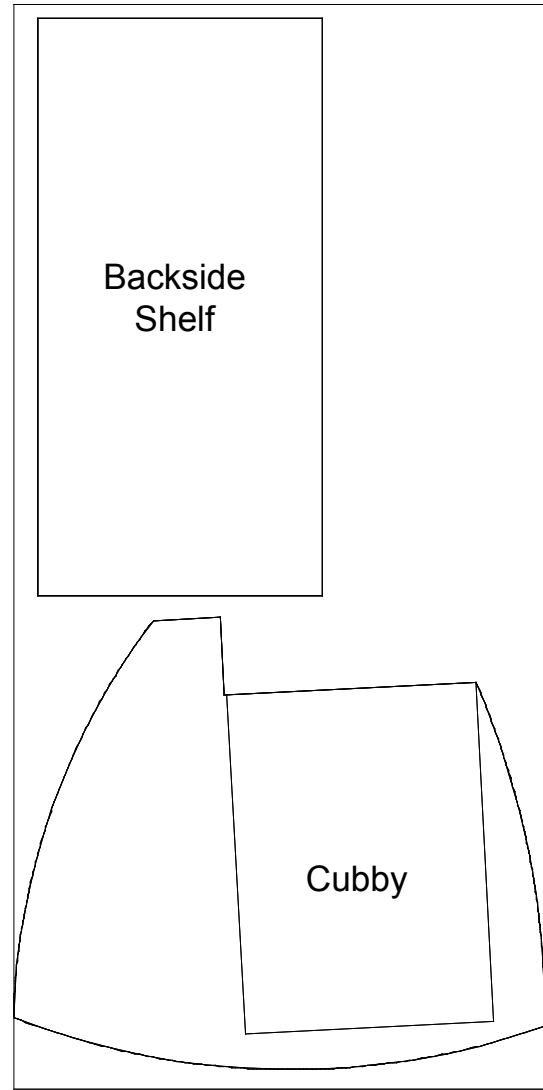

Level 1

WHEN DISASSEMBLING TIGHTEN ALL KNOBS TO PREVENT LOSS DURING SHIPPING

Top View of Each Level

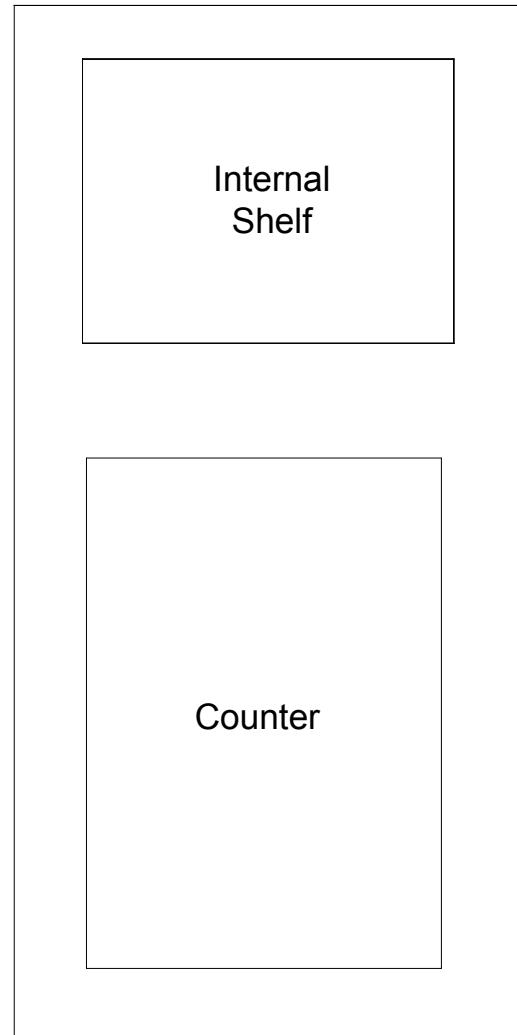

Level 1

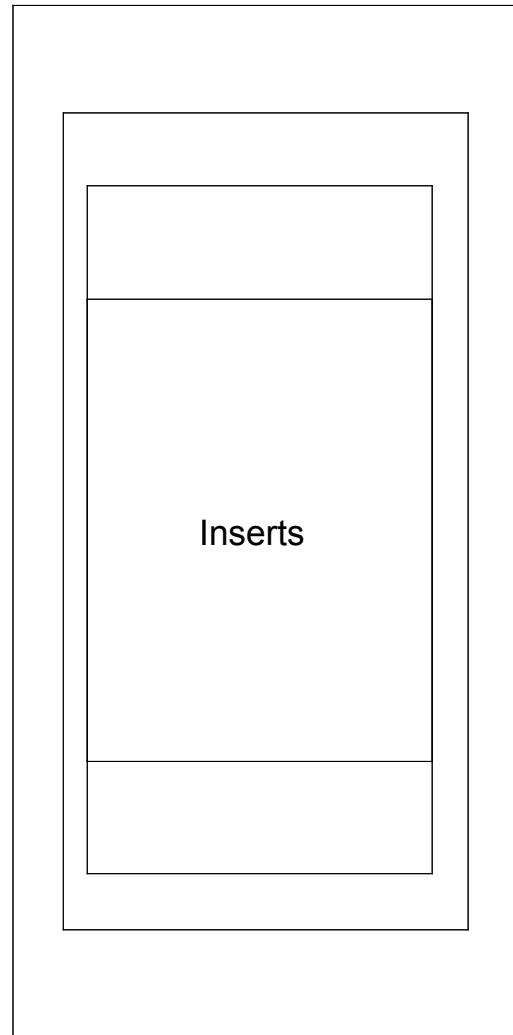

Level 2

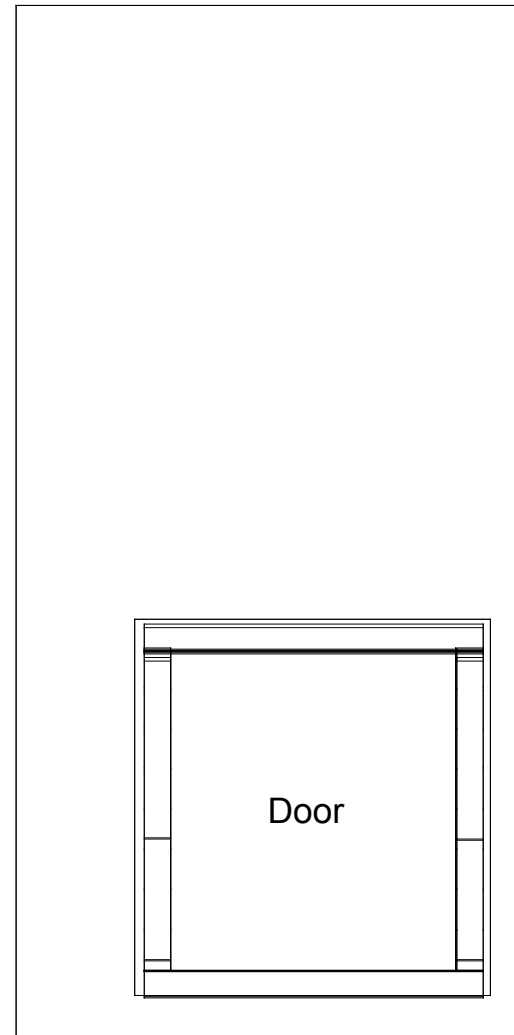

Level 3

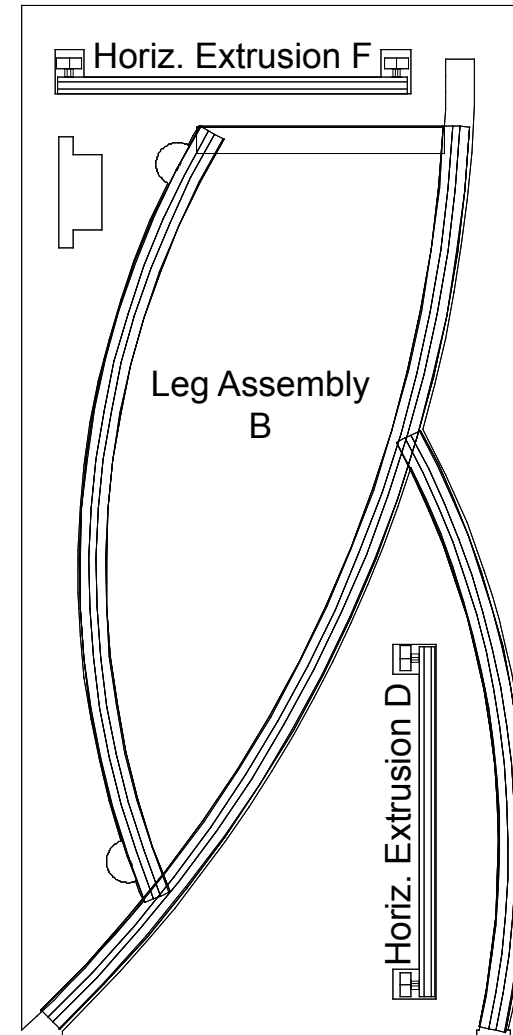

Level 4

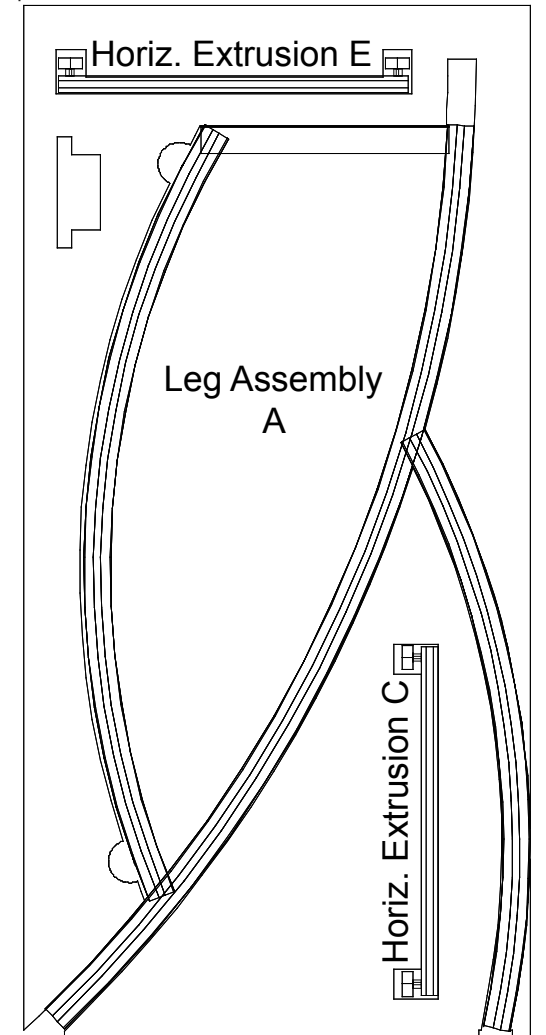

Level 5

WHEN DISASSEMBLING TIGHTEN ALL KNOBS TO PREVENT LOSS DURING SHIPPING